

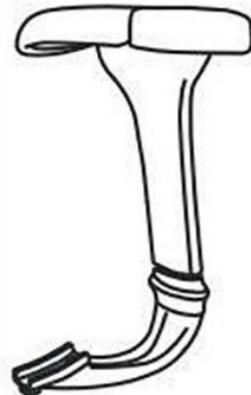

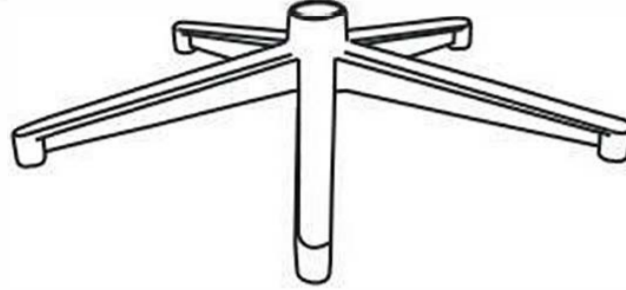

ERGOHUMAN ME7ERG/LE9ERG ASSEMBLY INSTRUCTION

PARTS LIST

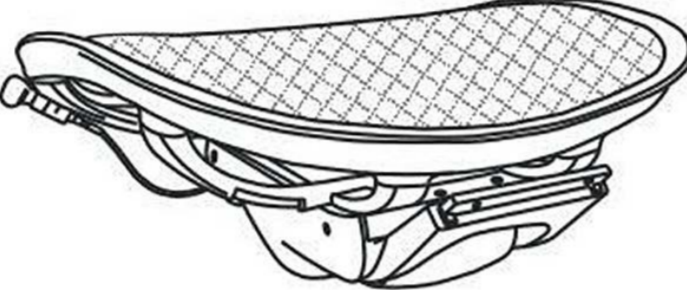

<p>①</p>  <p>CASTER x 5</p>	<p>④</p>  <p>RIGHT&LEFT ARM x 1EACH</p>
<p>②</p>  <p>BASE x 1</p>	<p>⑤</p>  <p>SEAT CUSHION x 1</p>
<p>③</p>  <p>GAS LIFT x 1</p>	<p>⑥</p>  <p>BACK CUSHION x 1</p>

HARDWARE



TYPE A ARM SCREWS&WASHER (FOR FRONT SCREW OPENING)

	1 1/4" X 1"
	SPARE SCREW

TYPE B ARM SCREWS&WASHER (FOR REAR SCREW OPENING)

	1 1/4" X 5/8"
	SPARE SCREW

TYPE C BACK SCREWS

	M8X17MM
	SPARE SCREW

ALLEN WRENCH

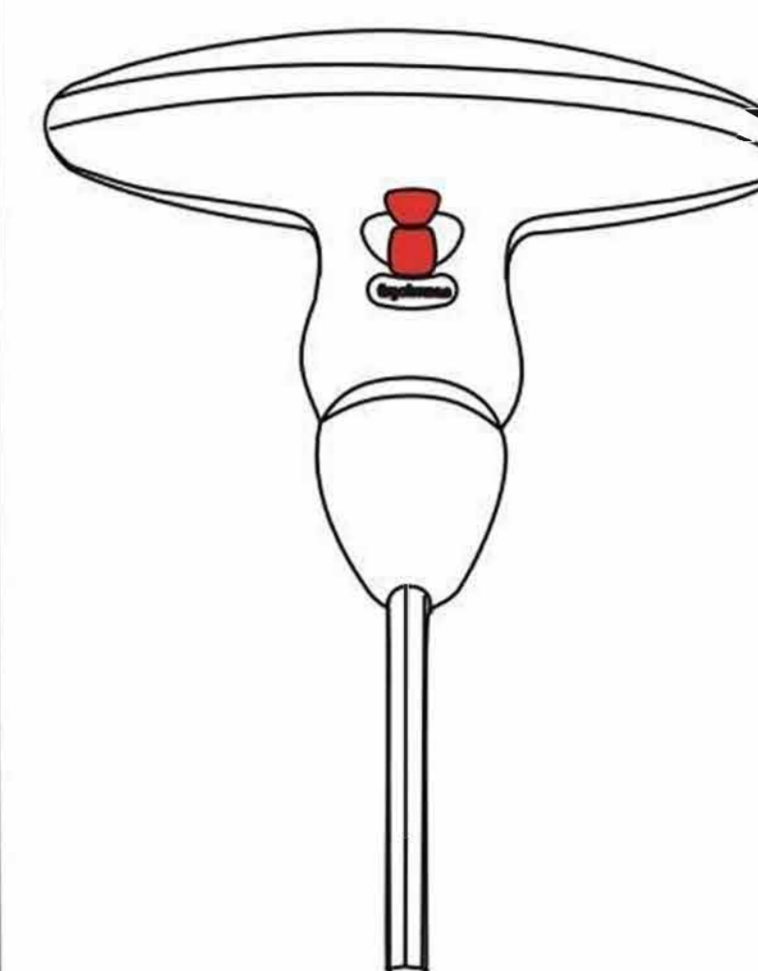

STEP 1.

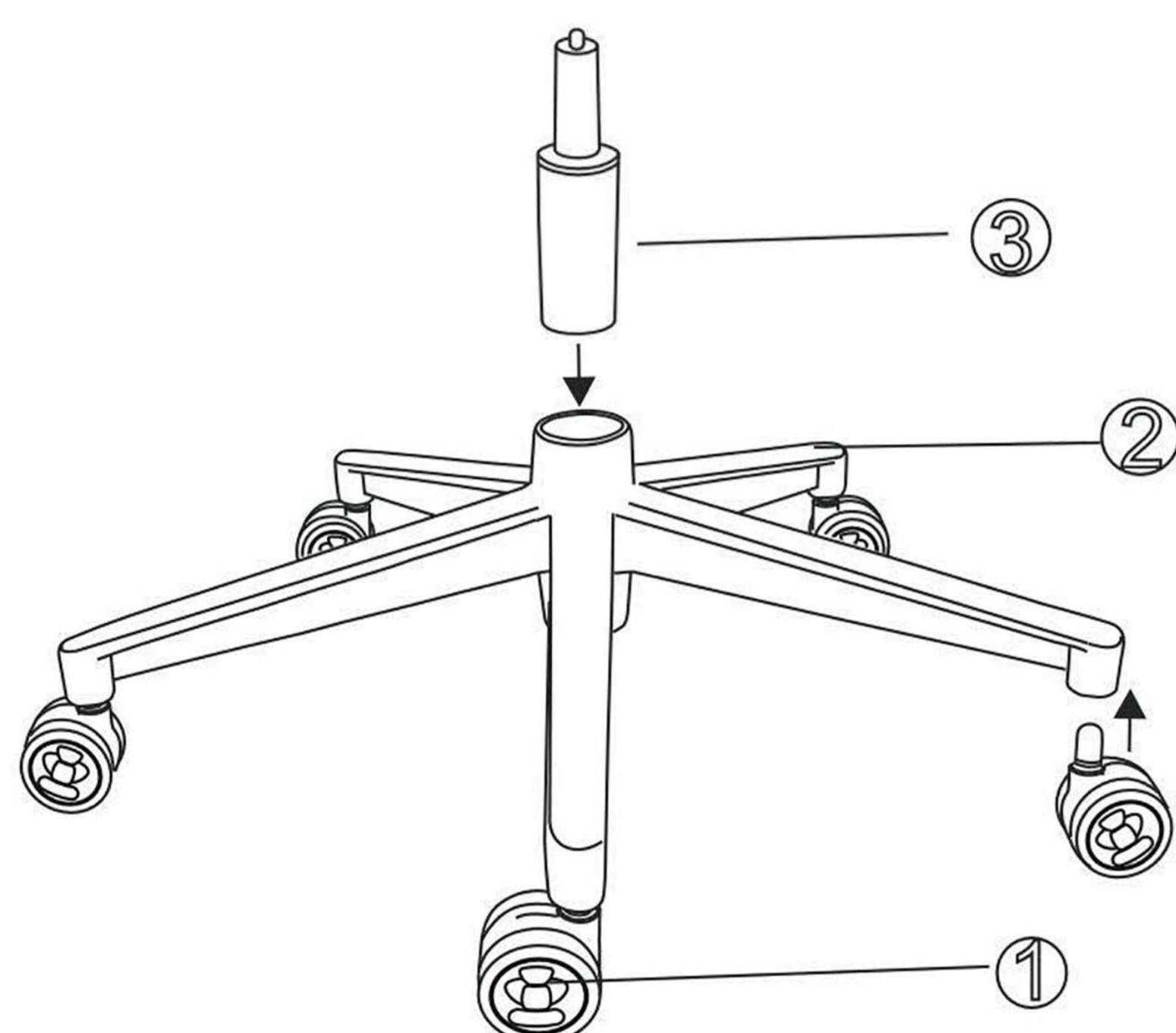

STEP 2.

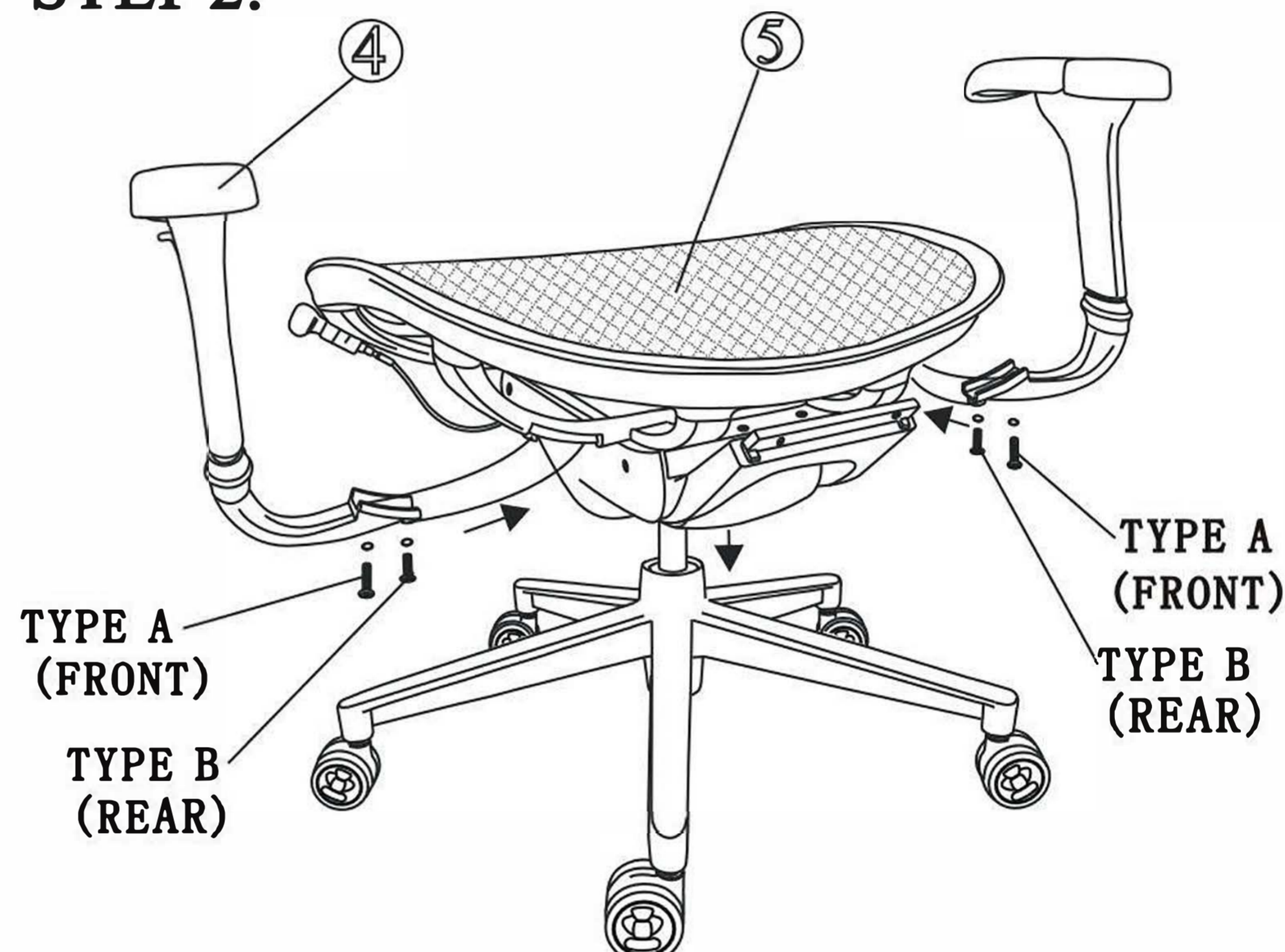

STEP 3.



STEP 4.



PREVENTIVE MAINTENANCE AND WARNING

- USE THIS PRODUCT ONLY FOR SEATING ONE PERSON AT A TIME.
- DO NOT USE CHAIR AS STEP STOOL/LADDER.
DO NOT USE CHAIR UNLESS ALL BOLTS,SCREWS ARE TIGHT.AT LEAST EVERY SIX MONTHS CHECK ALL BOLTS,SCREWS TO BE SURE THEY ARE TIGHT.
- IF ANY PARTS ARE MISSING,BROKEN,DAMAGED OR WORN,STOP USE OF THE PRODUCT UNTIL REPAIRS ARE MADE USING FACTORY AUTHORIZED PARTS.
- FAILURE TO FOLLOW THESE WARNINGS CAN RESULT IN SERIOUS INJURY.

available at:

 **humansolution**[®]

800.531.3746

info@thehumansolution.com
thehumansolution.com