



float™

Humanscale®



Introducing Float: **the world's most revolutionary height-adjustable table**

Thanks to its innovative and proprietary design, Float solves the problems and limitations of current-generation height-adjustable tables, gracefully adapting to a vast range of heights and weights with exceptional ease of use and safety features. Float's ingenious, constant-force spring allows it to move effortlessly and instantly between sitting height and standing height, while accommodating the ergonomic needs of 99% of users.

The dangers of sedentary work

While most office workers sit for the majority of their workdays, research shows that all-day sitting is a serious health risk, potentially leading to chronic disease. Even worse, the harmful effects of long-term sitting can't be offset by regular exercise or a healthy diet. But standing all day at work isn't healthy either, causing discomfort and swelling in the legs and feet. Therefore, the most effective way to maintain health and comfort in the workplace is to alternate periodically between sitting and standing postures.



Features

- Unmatched performance and ease of use encourage desk-bound workers to regularly alternate between sitting and standing postures for long-term health.
- Simple, single-handed counterbalance weight adjustment instantly accommodates changes in tabletop weight.
- Innovative safety feature allows up or down adjustment only when the desktop and contents are properly counterbalanced.
- With clean, architectural lines that belie its sophisticated functionality, Float complements any work environment while offering plenty of room under the work surface for legs, knees and feet.
- Built for a long, serviceable life and limited carbon footprint, Float is made using minimal parts and manufacturing processes, and is comprised predominantly of recyclable steel.

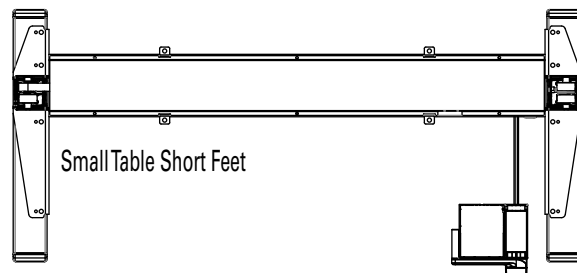
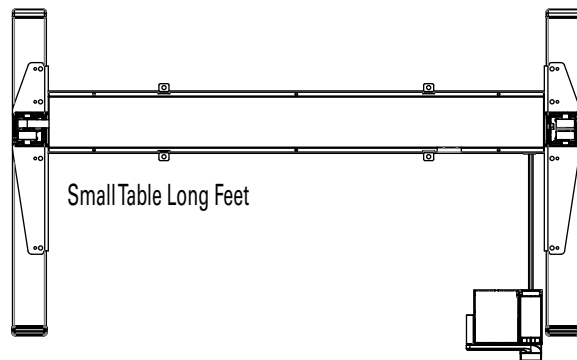
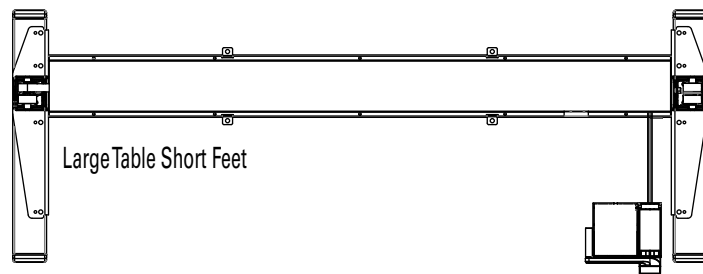
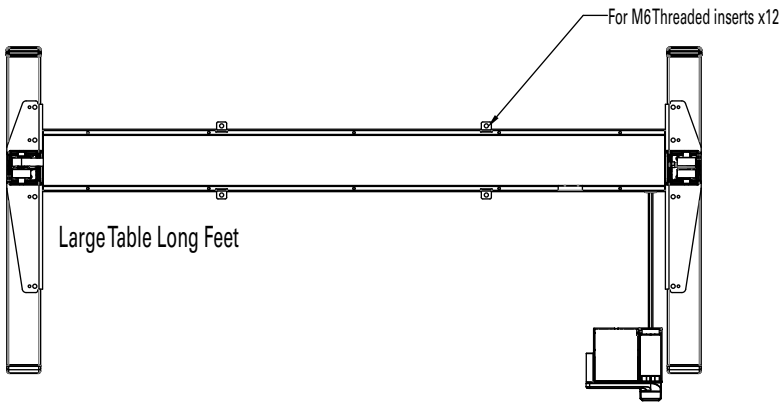

Specifications

- Provides an industry-leading 20" of height adjustability (27" to 47" from the floor, excluding tabletop thickness)
- Proprietary constant-force spring counterbalances up to an impressive 160 lbs. of desktop weight (including tabletop)
- Accommodates tabletop widths from 48" to 72" and depths from 24" to 30", including tabletops from most manufacturers
- Meets BIFMA requirements for load, capacity and stability
- Made from recyclable steel and aluminum
- Includes a 5-year, 24/7 warranty

Colors and Finishes

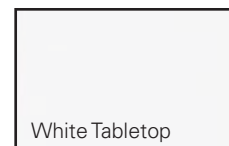
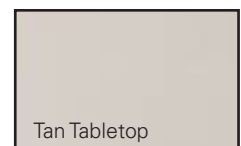
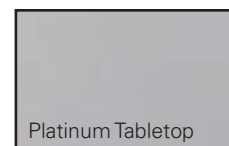
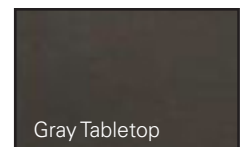
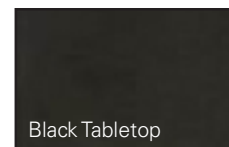
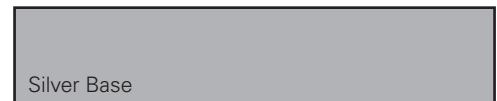

available at:



800.531.3746

info@thehumansolution.com
thehumansolution.com



Creating a more comfortable place to work