

Keyboard Systems



"A decade of ergonomics research shows that using a negatively sloped adjustable keyboard tray maximizes the time spent working in neutral hand, wrist and upper body postures. These postural benefits can't be achieved by just using a keyboard on a height adjustable work surface."
—Professor Alan Hedge, Cornell University



A key component of an ergonomic workstation and a must for any keyboard user, a well-designed articulating keyboard support offers serious protection from carpal tunnel syndrome, neck and back pain, and other musculoskeletal issues.

Since 1999, Humanscale has been the leading manufacturer of articulating keyboard systems, and today sells more than all other manufacturers combined.

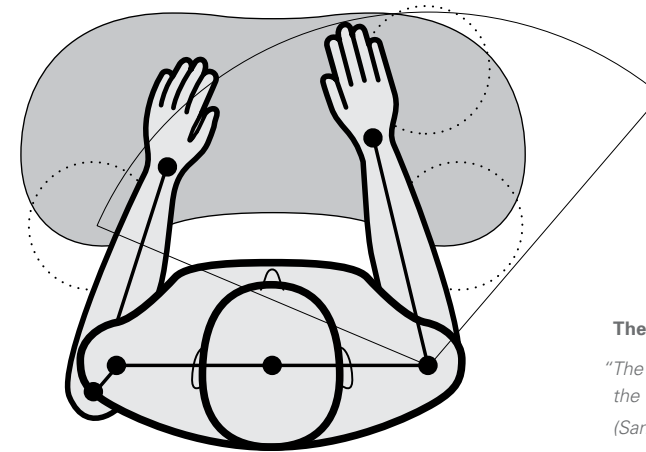

The Neutral Reach Zone

"The area that can be conveniently reached with a sweep of the forearm while the upper arm hangs in a natural position at the side."

(Sanders & McCormick, 1993)

Humanscale keyboard systems ensure nearly all users can work consistently within their Neutral Reach Zone to maintain a low-risk posture.

Without a keyboard support

- User hunches forward
- Wrists extended
- No chair support
- Risk of carpal tunnel syndrome and neck, shoulder and back pain

With a keyboard support

- Relaxed upper body
- Straight wrists
- User's back engaged with chair
- Neutral, low-risk, sustainable posture

Keyboard Components

Mechanisms

Humanscale offers nine award-winning, negative-tilt mechanism options, from our original standard-bearer, the 2G, to our latest 5G, which combines easy dial-a-tilt and height adjustability with the strongest, most stable arm on the market. All of our mechanisms encourage low-risk typing postures and feature easy and intuitive adjustability.

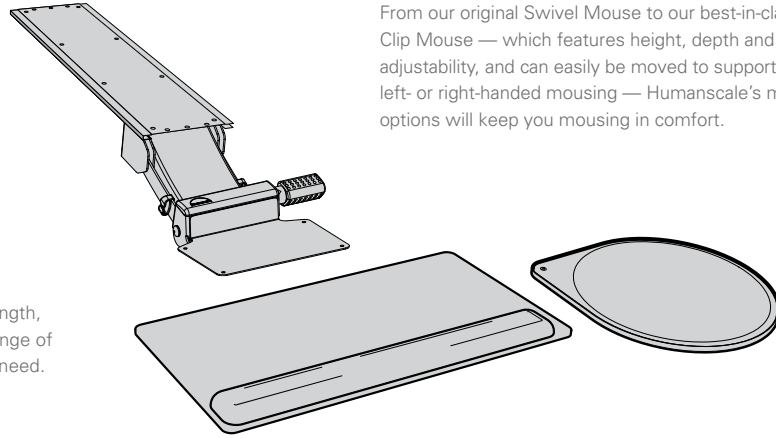

Mouse Platforms

From our original Swivel Mouse to our best-in-class Clip Mouse — which features height, depth and lateral adjustability, and can easily be moved to support left- or right-handed mousing — Humanscale’s mouse options will keep you mousing in comfort.

Keyboard Platforms

Made of 1/4" phenolic resin, which combines strength, durability and a slim profile, Humanscale’s wide range of keyboard platform options will accommodate any need. Available with Technogel or foam palm supports.

Desk Configuration Compatibility Guide

Humanscale Keyboard Systems offer mix-and-match components for a custom solution to virtually any desk situation. Here are a few recommended platform options for some of the most common desk configurations. Consult your Humanscale rep for the Keyboard System solution that’s right for you.

Straight Desk Configuration



Recommended Platforms

- 900 Standard keyboard platform with Clip Mouse *shown*
- 500 Big keyboard platform *shown*
- 950 Standard Compact keyboard platform with Clip Mouse
- 550 Big Compact keyboard platform

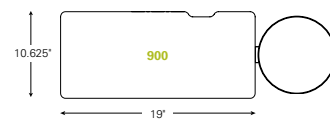

Diagonal Desk Configuration

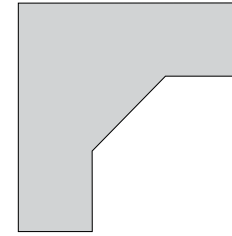

Recommended Platforms

- 700 Diagonal keyboard platform with Clip Mouse *shown*
- 400 Diagonal Big keyboard platform *shown*
- 900 Standard keyboard platform with Clip Mouse
- 950 Standard Compact keyboard platform with Clip Mouse

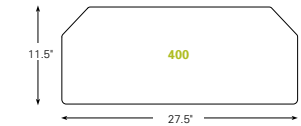
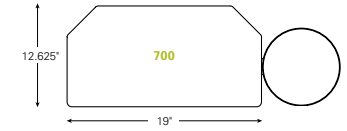

Radiused Desk Configuration

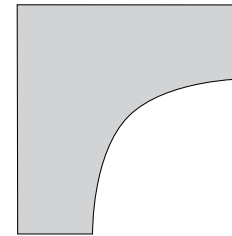

Recommended Platforms

- 800 Radiused keyboard platform with Clip Mouse *shown*
- 550 Big Compact keyboard platform *shown*
- 900 Standard keyboard platform with Clip Mouse
- 950 Standard Compact keyboard platform with Clip Mouse

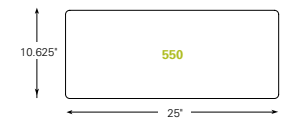
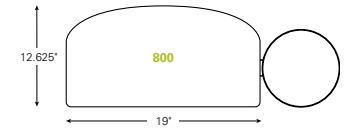

90-Degree Desk with DE200 Corner Sleeve Configuration

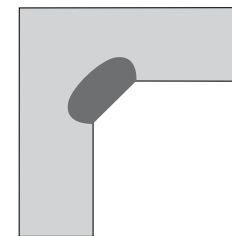

Recommended Platforms

- 950 Standard Compact keyboard platform with Clip Mouse *shown*
- 600 Extender keyboard platform with Clip Mouse *shown*
- 700 Diagonal keyboard platform with Clip Mouse
- 900 Standard keyboard platform with Clip Mouse

