

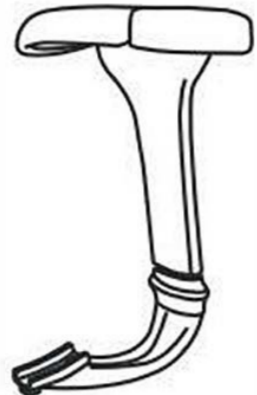

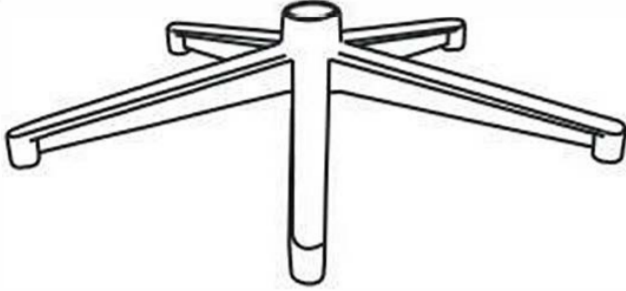

# ERGOHUMAN ME7ERG/LE9ERG ASSEMBLY INSTRUCTION

## PARTS LIST

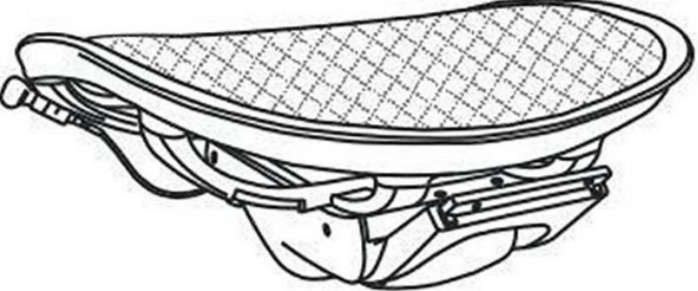

①  CASTER x 5	④  RIGHT&LEFT ARM x 1EACH
②  BASE x 1	⑤  SEAT CUSHION x 1
③  GAS LIFT x 1	⑥  BACK CUSHION x 1

## HARDWARE



### TYPE A ARM SCREWS&WASHER (FOR FRONT SCREW OPENING)

	1 1/4" X 1"
	SPARE SCREW

### TYPE B ARM SCREWS&WASHER (FOR REAR SCREW OPENING)

	1/4" X 5/8"
	SPARE SCREW

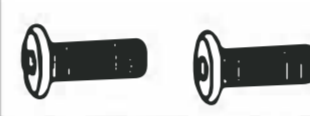
### TYPE C BACK SCREWS

	M8X17MM
	SPARE SCREW

### ALLEN WRENCH

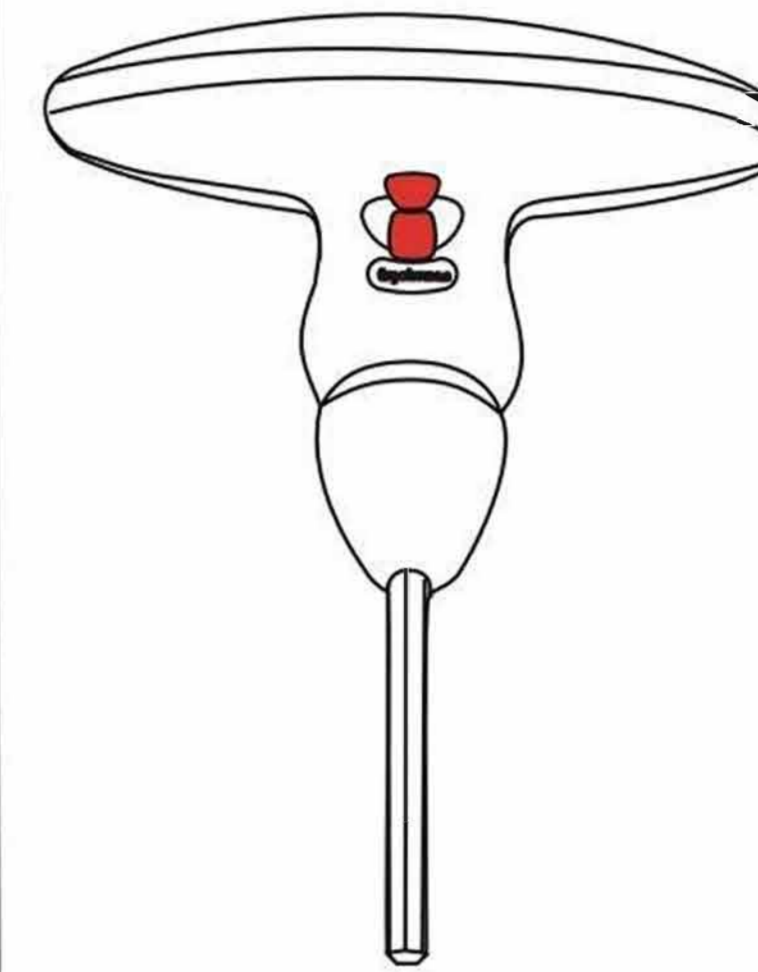

### STEP 1.

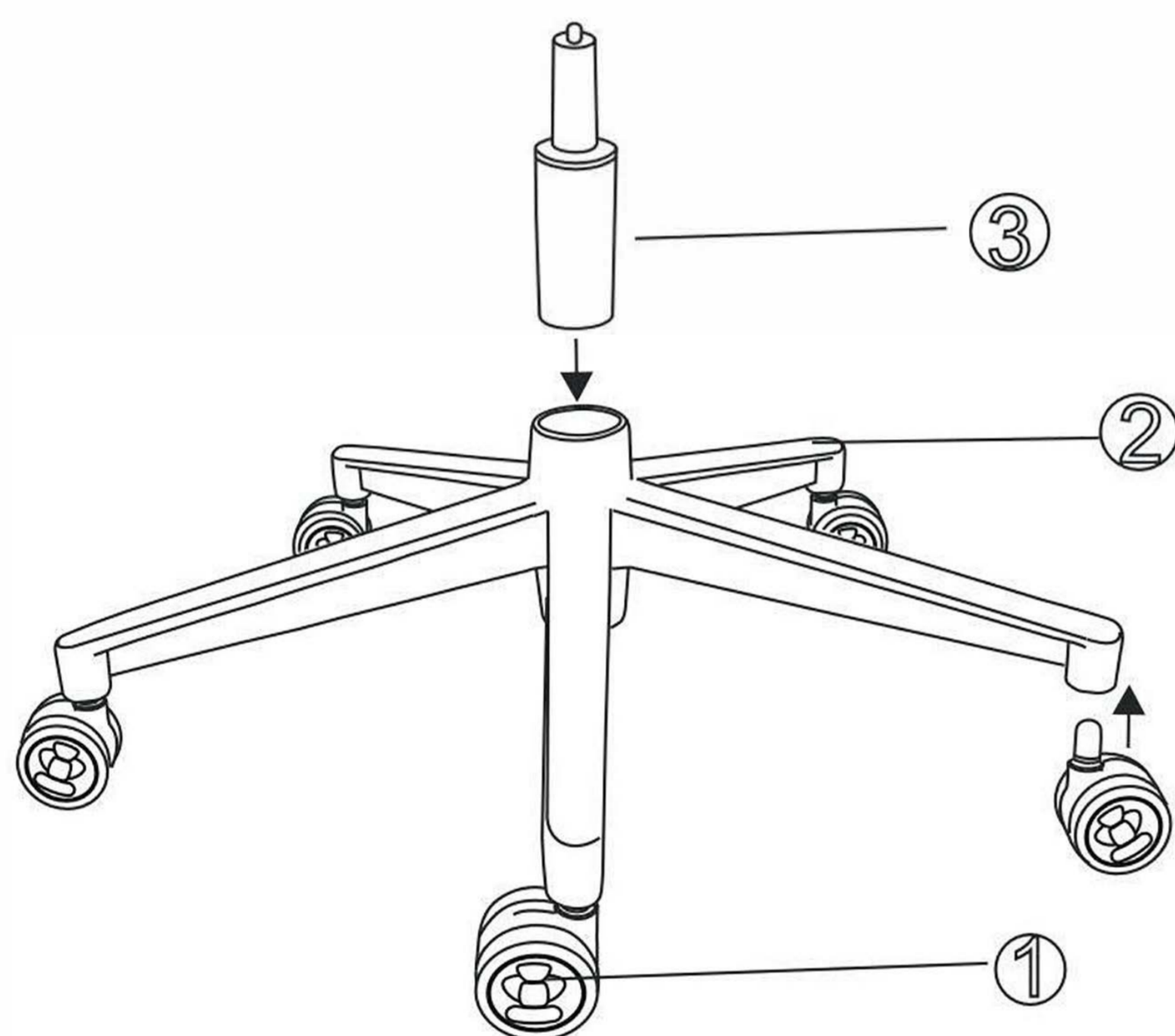

### STEP 2.

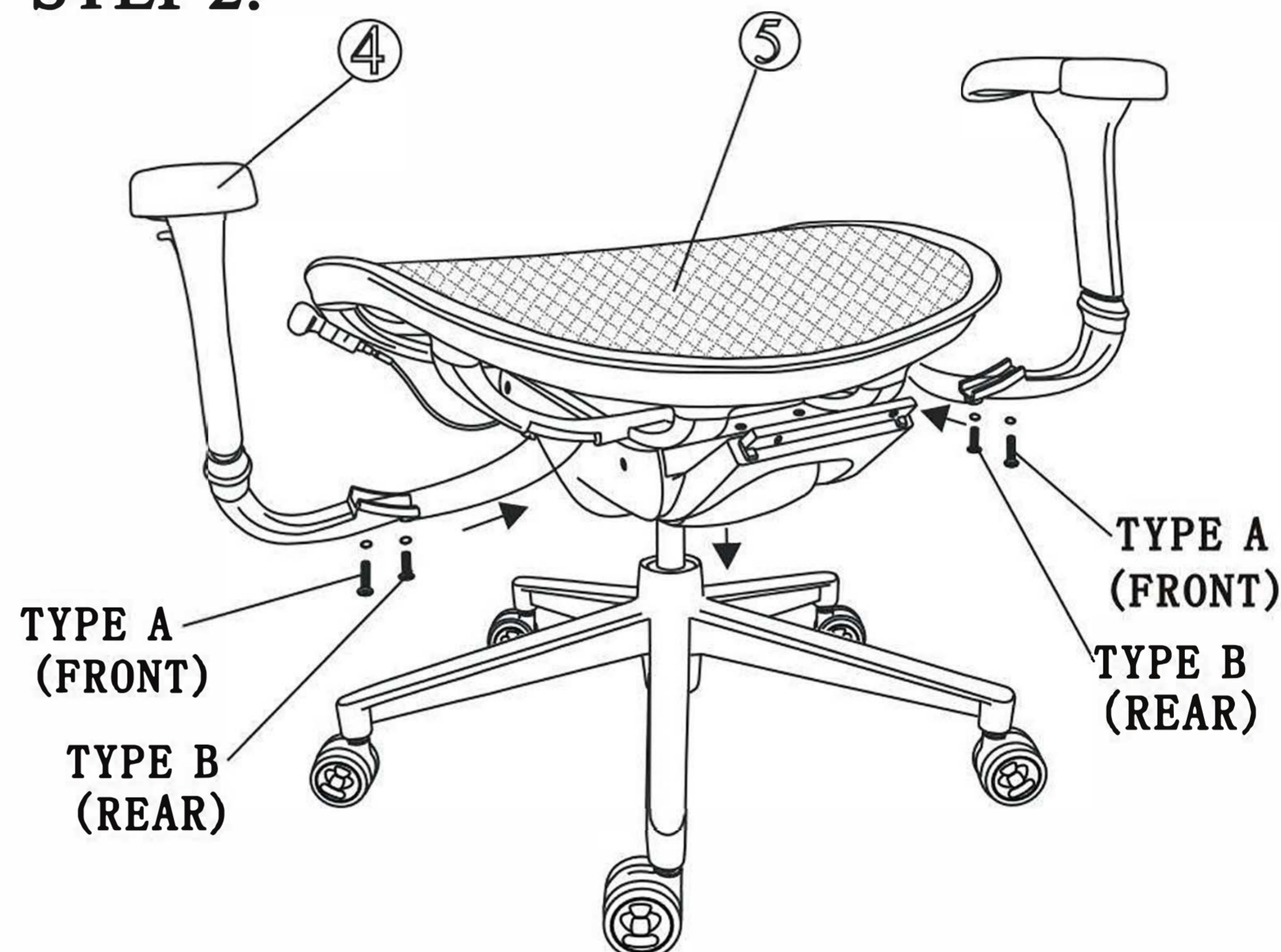

### STEP 3.



### STEP 4.



### PREVENTIVE MAINTENANCE AND WARNING

- USE THIS PRODUCT ONLY FOR SEATING ONE PERSON AT A TIME.
- DO NOT USE CHAIR AS STEP STOOL/LADDER.  
DO NOT USE CHAIR UNLESS ALL BOLTS,SCREWS ARE TIGHT.AT LEAST EVERY SIX MONTHS CHECK ALL BOLTS,SCREWS TO BE SURE THEY ARE TIGHT.
- IF ANY PARTS ARE MISSING,BROKEN,DAMAGED OR WORN,STOP USE OF THE PRODUCT UNTIL REPAIRS ARE MADE USING FACTORY AUTHORIZED PARTS.
- FAILURE TO FOLLOW THESE WARNINGS CAN RESULT IN SERIOUS INJURY.

available at:

 humansolution®

800.531.3746  
info@thehumansolution.com  
thehumansolution.com