

Model 7011 Installation Instructions

1

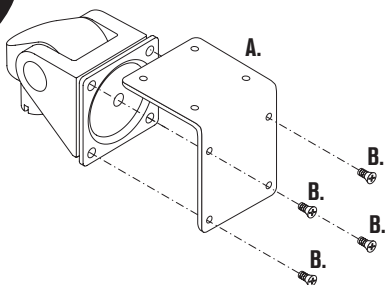

2

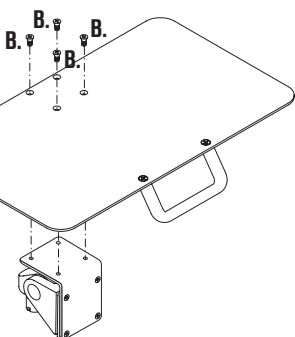

3

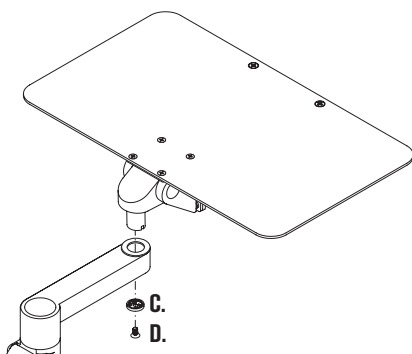



I N N O V A T I V E

Model 7011 Parts List

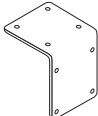
ITEM	DESCRIPTION / PART NO.	QUANTITY
------	------------------------	----------

A.	 Tilter Adapter Bracket 104592	1
----	---	---

B.	 10-32 x 3/8" Philips Flat Head Screw 701164	8
----	---	---

C.	 Dog Washer 105189	1
----	---	---

D.	 10-32 x 3/8" Screw w/Lock Patch 705198	1
----	--	---

available at:



800.531.3746
info@thehumansolution.com
thehumansolution.com

This product is protected by one or more of the following U.S. Patent Nos., and other United States and foreign patents applied for: 6,076,785, 6,273,383, 6,409,134, 6,478,274, 6,499,704, 6,505,988, 6,609,691, 6,19,606, 6,719,253, 6,726,167, 6,736,364, 6,783,105, 6,854,698, 6,915,994, 6,935,883, 6,955,328, 6,983,917, 6,986,489, 7,014,157, 7,017,874, 7,048,242, 7,059,574, 7,063,296, 7,066,433, 7,066,435, D435,852, D491,952, D492,893.