

UPLIFT DESK[®] Spacer for CPU Holder ACC030

Package Contents:

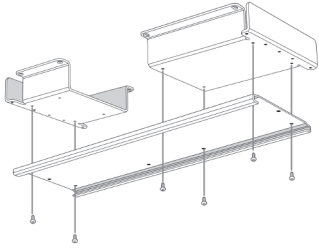
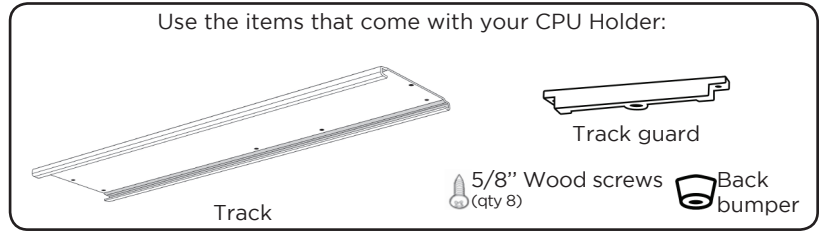
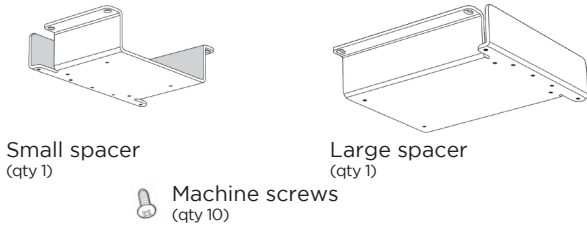

Step 1

Using six (6) Machine screws, attach the track to the Small and Large spacers as shown.

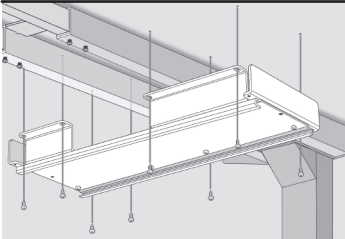

Step 2

Place the assembly over the crossbar ends* (Note: If your desk uses short-style crossbar ends, place assembly over the center rails). Mark screw locations, pre-drill, then attach to desktop using eight (8) 5/8" Wood screws.

Note-

When placing the assembly over the crossbar end, you can have it pointing in either direction. If you want your CPU to be positioned closer to the back of the desk, attach the assembly with the large spacer behind the crossbar end (see fig. 1). If you'd prefer your CPU to be closer to the front of the desk, mount the assembly with the large spacer in front of the crossbar end (see fig. 2).

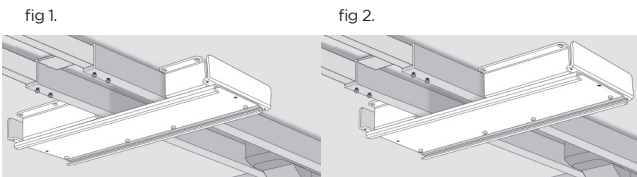

Step 3

Using one (1) Machine screw, attach the back bumper to the rear side of the assembly.

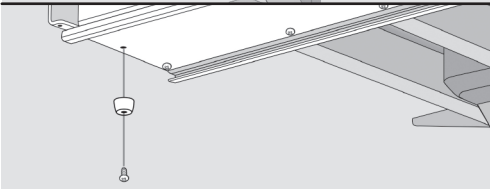

Step 4

Slide the CPU holder onto the track.

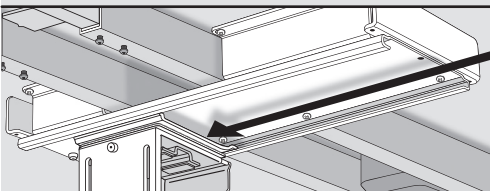

Step 5

Use the three (3) remaining Machine screws to attach the track guard to prevent the CPU from sliding off.

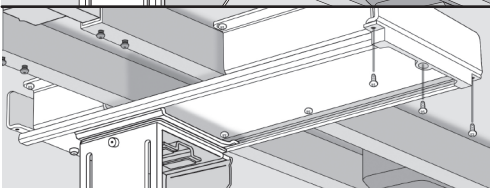

© **Copyright Notice:** These instructions are a component of the UPLIFT Spacer. These instructions are part of the scope of delivery, even if the item is resold. These instructions are also available on the UPLIFT Desk website: upliftdesk.com. Excerpts or copies may not be forwarded to third parties or used in any other published form without the prior written consent of UPLIFT Desk. These instructions are subject to United States copyright law.

UPLIFT DESK[®] Spacer for Keyboard Tray ACC030

Package Contents:

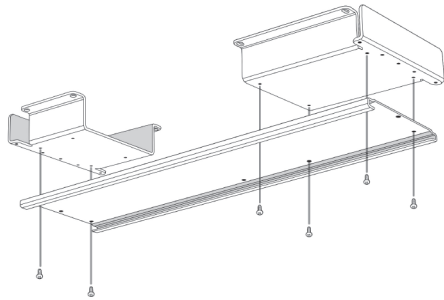
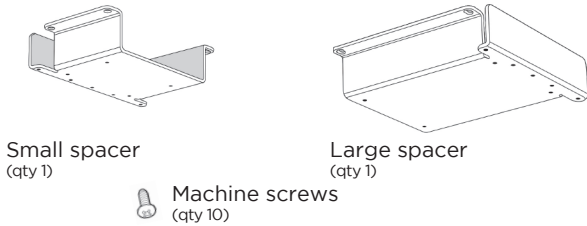

Step 1

Using six (6) Machine screws, attach the track to the Small and Large spacers as shown.

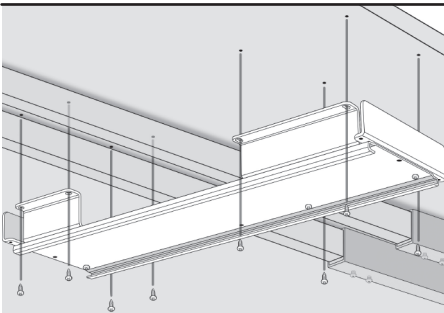

Step 2

Place the assembly over the crossbar rails* (Note: If your desk uses short-style crossbar ends, place assembly over the center rails). Mark screw locations, pre-drill, then attach to desktop using eight (8) 5/8" Wood screws.

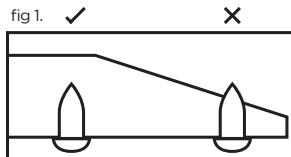

Note-

*When pre-drilling on a desktop with a center-cut ergo edge, take care to ensure that the screw is not too close to the ergo edge to avoid piercing the desk-top with the screw. (see fig. 1)

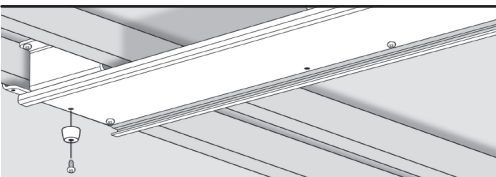

Step 3

Using one (1) Machine screw, attach the back bumper to the rear side of the assembly.

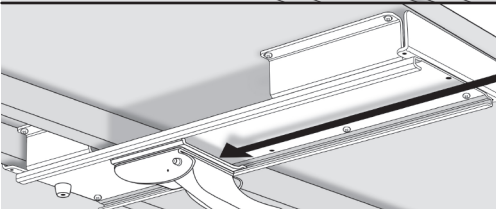

Step 4

Slide the keyboard tray mechanism onto the track.

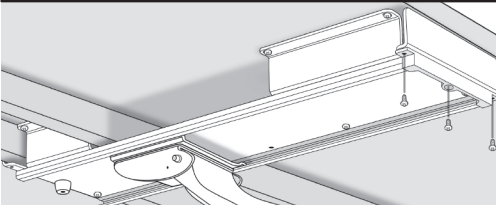

Step 5

Use the three (3) remaining Machine screws to attach the track guard to prevent the keyboard tray mechanism from sliding off.

© **Copyright Notice:** These instructions are a component of the UPLIFT Spacer. These instructions are part of the scope of delivery, even if the item is resold. These instructions are also available on the UPLIFT Desk website: upliftdesk.com. Excerpts or copies may not be forwarded to third parties or used in any other published form without the prior written consent of UPLIFT Desk. These instructions are subject to United States copyright law.